

SCONA

- harmonious design with centrally-placed waste
- can be installed absolutely flush to floor
- also available in the shades of the Coordinated Colours Collection
- made of KALDEWEI steel enamel
- flush-fitting recessed waste cover (only in combination with the KA 90 waste fittings)



Similar illustration

	Combined Tray & Waste depth	Waste fitting depth
KA 90	103	81
KA 90 extra flat	92	70
KA 90 ultra flat	83	61
KA 90 vertical	49	81

See page 291.

Model 913

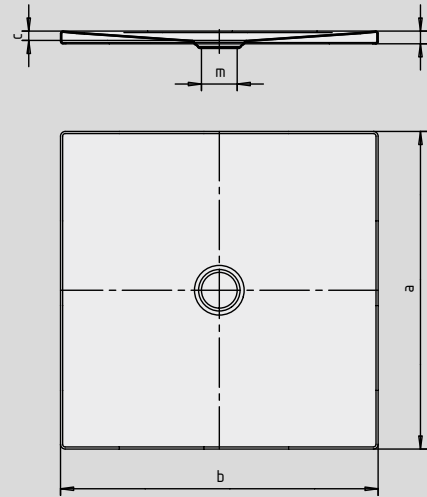

Model 912

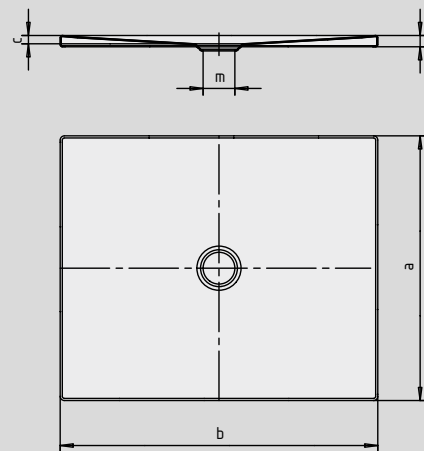

SECURE⁺

Model No.	908	911	940	912	941	913	942	914	915	
External length	a	750	800	700	750	800	900	750	800	900 mm
External width	b	800	800	900	900	900	900	1000	1000	1000 mm
Depth	c	23	23	23	23	23	23	23	23	23 mm
Height of rim	i	32	32	32	32	32	32	32	32	32 mm
Diameter of drain hole	m	90	90	90	90	90	90	90	90	90 mm
Weight of the enamelled shower tray in kg		16	17	17	18	19	21	20	21	23
Anti-slip		492 x 492	492 x 492	492 x 492	492 x 492	492 x 492	492 x 492	492 x 492	492 x 492	492 x 492 mm
Full anti-slip		692 x 740	740 x 740	644 x 836	692 x 836	740 x 836	836 x 836	692 x 932	740 x 932	836 x 932 mm
SECURE PLUS		all-over	all-over	all-over	all-over	all-over	all-over	all-over	all-over	all-over

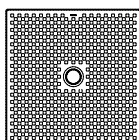

The TÜV Rheinland confirms the following properties of KALDEWEI's anti-slip, full anti-slip and SECURE PLUS finish:

- Assessment group **B** for wet barefoot areas (**DIN 51097**)
- Assessment group **R 10** for slip-resistant properties in work rooms and areas with an increased risk of slipping (**DIN 51130**)

All SCONA models are available either with anti-slip, full anti-slip or SECURE PLUS.

Model 968 with full anti-slip or SECURE PLUS fits DIN barrier-free 18040-2.