

# SCONA WITH LOW PROFILE SUPPORT

- harmonious design with centrally-placed waste
- also available in the shades of the Coordinated Colours Collection
- made of KALDEWEI steel enamel
- flush-fitting recessed waste cover (only in combination with the KA 90 waste fittings)

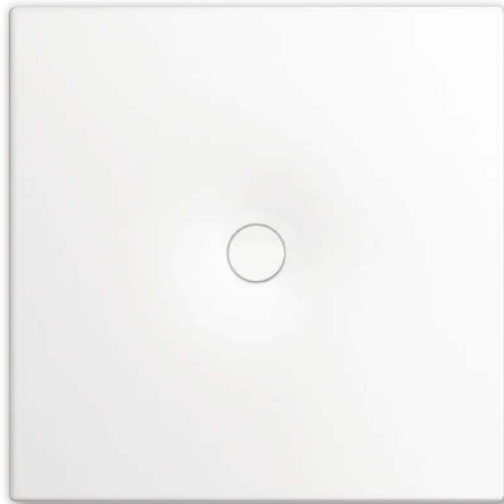

Similar illustration

	Combined Tray & Waste depth	Waste fitting depth
KA 90	103	81
KA 90 extra flat	92	70
KA 90 ultra flat	83	61
KA 90 vertical	49	81

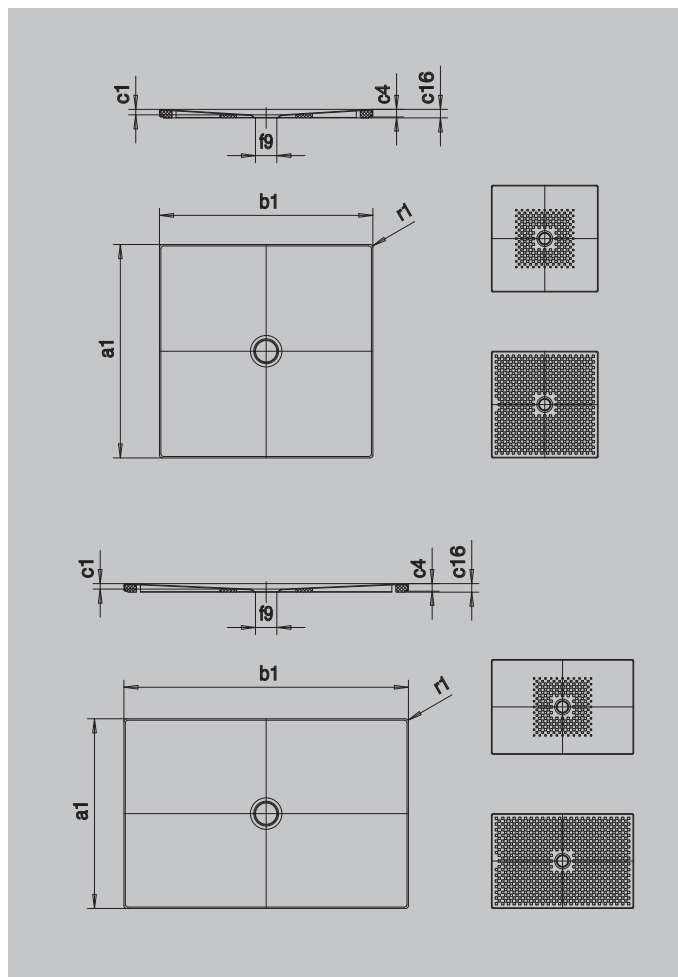

SECURE<sup>[+]</sup>

Model	908	911	940	912	941	913	942	914	915	
External length	a <sub>1</sub>	750	800	700	750	800	900	750	800	900 mm
External width	b <sub>1</sub>	800	800	900	900	900	900	1000	1000	1000 mm
Internal depth	c <sub>1</sub>	23	23	23	23	23	23	23	23	23 mm
Height of rim	c <sub>4</sub>	32	32	32	32	32	32	32	32	32 mm
Height with low profile support	c <sub>16</sub>	37	37	37	37	37	37	37	37	37 mm
Diameter of drain hole	f <sub>9</sub>	90	90	90	90	90	90	90	90	90 mm
External radius	r <sub>1</sub>	12	12	12	12	12	12	12	12	12 mm
Weight of the enamelled shower tray		16	17	17	18	19	21	20	21	23 kg
Anti-slip		492 x 492	492 x 492	492 x 492	492 x 492	492 x 492	492 x 492	492 x 492	492 x 492	492 x 492 mm
Full anti-slip		692 x 740	740 x 740	644 x 836	692 x 836	740 x 836	836 x 836	692 x 932	740 x 932	836 x 932 mm
SECURE PLUS		all-over	all-over	all-over	all-over	all-over	all-over	all-over	all-over	all-over

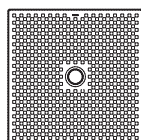

The TÜV Rheinland confirms the following properties of KALDEWEI's anti-slip, full anti-slip and SECURE PLUS finish:

- Assessment group **B** for wet barefoot areas (**DIN 51097**)
- Assessment group **R 10** for slip-resistant properties in work rooms and areas with an increased risk of slipping (**DIN 51130**)

All SCONA models are available either with anti-slip, full anti-slip or SECURE PLUS.

Model 968 with full anti-slip or SECURE PLUS fits DIN barrier-free 18040-2.