

CAYONOPLAN

- floor-level shower
- classic design with inner contour
- perfect match for the CAYONO model range
- large standing area with central waste at short side
- made of KALDEWEI steel enamel



Similar illustration

	Total height	Fitting height
KA 90	98	81
KA 90 extra flat	87	70
KA 90 ultra flat	78	61
KA 90 vertical	49	81

Model 2251

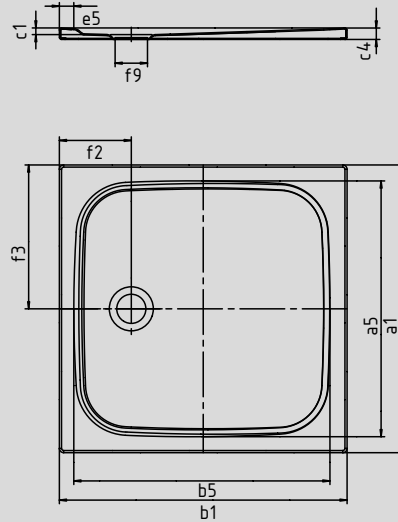

Model 2255 with low profile support

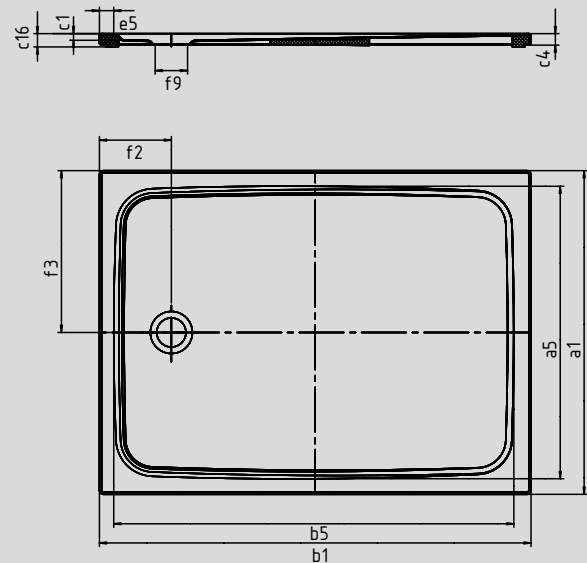

SECURE⁺

Model No.		2257	2258	2259	2261
External length	a ₁	900	1000	750	750 mm
Internal length	a ₅	790	890	640	640 mm
External width	b ₁	1000	1000	1100	1200 mm
Internal width	b ₅	890	890	990	1090 mm
Internal depth	c ₁	18	18	18	18 mm
Height of rim	c ₄	32	32	32	32 mm
Height with support	c ₁₆	37	37	37	37 mm
Width of rim	e ₅	50	50	50	50 mm
Distance bath edge to centre of drain hole	f ₂	200	200	200	200 mm
Distance bath edge to centre of drain hole	f ₃	450	500	375	375 mm
Diameter of drain hole	f ₉	90	90	90	90 mm
Weight of the enamelled shower tray in kg		23	27	21	24
Anti-slip		495 x 495	495 x 495	375 x 535	375 x 535 mm
Full anti-slip		695 x 835	815 x 835	575 x 935	575 x 1035 mm
SECURE PLUS		full-surface	full-surface	full-surface	full-surface

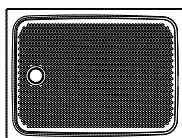

The German technical inspection association TÜV Rhineland has certified KALDEWEI's anti-slip, full anti-slip and SECURE PLUS finishes as having anti-slip properties compliant with:

- quality class **B** for wet barefoot areas (**DIN 51097**)
- quality class **R 10** for anti-slip characteristics in work spaces and working areas with an increased slip risk (**DIN 51130**)

All CAYONOPLAN models are available with **anti-slip, full anti-slip and SECURE PLUS**